

03-12 Ford F-250 thru F-550 Super Duty Crew Cab – 60/40 Split Bench Seats *Underseat Storage*

Fits DU-HA Part Numbers

20094	20068
20065	20069
20066	20070
20067	

Tools Required:

- // 18mm socket
- // T-40 Torx

Installation Instructions:

- 1 Lift up the back seats.
- 2 On the driver's side floor in the back seat, remove the 2nd bolt in that secures the metal tray to the floor, using an 18mm socket.
- 3 Fold out the metal trays underneath the back seats.
- 4 Remove the 6 bolts on the top of the tray that hold the tray in place, using a T-40 Torx.
- 5 Remove the metal tray.
- 6 Secure all the bolts back in place, except for the 2 bolts closest to the back of the cab. Those remaining 2 bolts will be used to secure the DU-HA in place.
- 7 Set the DU-HA under the back seats.
- 8 Line up the pre-drilled holes in the DU-HA with the back 2 bolt holes. Secure the back 2 bolts in place, using the T-40 Torx.
- 9 If desired, install foam organizer/gun racks with plastic stiffeners by sliding them into the channel slots in the DU-HA until they hit the bottom of the DU-HA (as pictured).

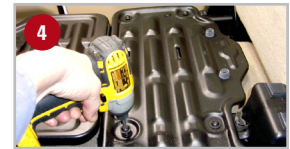

Safety Instructions:

Warning: Seat bottom must be latched down at all times while vehicle is moving. Make sure the DU-HA is secured in the vehicle according to installation instructions. Do not store explosives or hazardous materials in the DU-HA. Do not place loaded guns in the DU-HA.

For further instructions refer to truck owners manual or contact DU-HA, Inc.

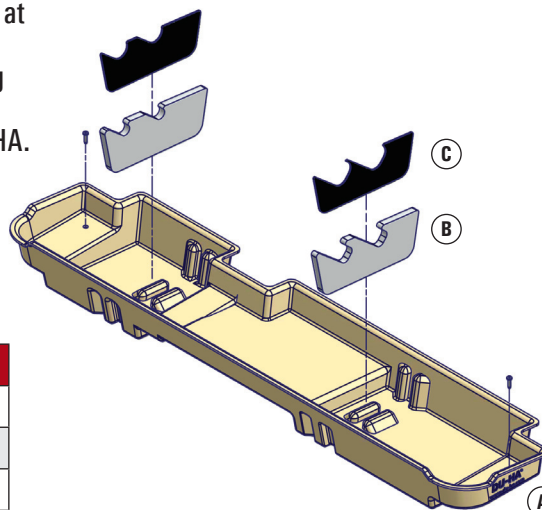

Part	Description	Qty
A	DU-HA Storage Unit	1
B	Foam Organizer / Gun Rack	2
C	Plastic Stiffener	2

Note: Behind-the-seat storage is also available for this truck. Visit www.du-ha.com for more information.