

2014-2019 Chevrolet & GMC Silverado/Sierra Double Cab Underseat Storage

Fits DU-HA Part Numbers
10304
10305
10306

Installation Instructions:

- 1 Lift up the bottoms of both sides of the back seat.
- 2 Remove the jack tool bag under the back seat by unscrewing the wingnut. *(Set the jack tool bag with wingnut aside temporarily. You will need to reinstall these later on, exactly as they were originally installed.)*
- 3 Position the DU-HA (A) under the back seat, so the exposed threaded stud (from removing the jack tool bag) fits up through the pre-drilled hole in the back center of the DU-HA.
- 4 Reinstall the jack tool bag by tightening the wingnut on top of the exposed threaded stud and the DU-HA (A), as pictured.
- 5 Install the Foam Organizer / Gun Rack / Plastic Stiffeners (B) by sliding them into the channel slots inside the DU-HA (A), making sure the high side of each piece faces towards the front of the truck, as pictured.
- 6 Lower the bottoms of both sides of the back seat to return them to their original position.



Safety Instructions:

Warning: Seat bottom must be latched down at all times while vehicle is moving. Make sure the DU-HA is secured in the vehicle according to installation instructions. Do not store explosives or hazardous materials in the DU-HA. Do not place loaded guns in the DU-HA. For further instructions refer to truck owners manual or contact DU-HA, Inc.



2 shotguns or rifles without scopes will fit in gun rack, as pictured above.

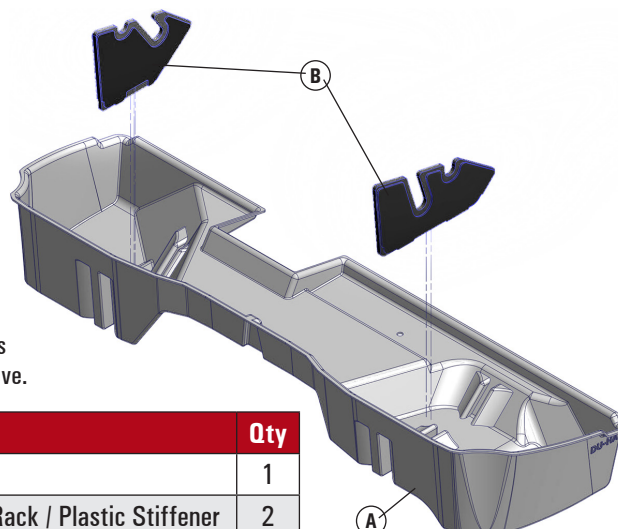

Part	Description	Qty
A	DU-HA Storage Unit	1
B	Foam Organizer / Gun Rack / Plastic Stiffener	2