

02-19 Dodge Ram 1500 Quad Cab/Crew Cab (Classic) 03-19 Dodge Ram 2500 & 3500 Quad Cab/Crew Cab (Classic) *Underseat Storage*

Fits DU-HA Part Numbers
30086
30017
30019

Materials Needed:

- // 13mm socket
- // 18mm socket

Installation Instructions:

- 1 Flip up the bottoms of the back seats.
- 2 If your truck came equipped with optional metal trays, remove each tray by removing the two large bolts using an 18mm socket and the two small nuts using a 13mm socket. Once you have removed the metal trays, replace the braces, large bolts, and smaller nuts.
- 3 Remove the plastic push pin from carpet behind cup-holders, in the middle of the cab.
- 4 Set the DU-HA in the floor of the truck (as shown).
- 5 Secure the DU-HA in the truck using the Lag Screw (D) provided. Thread screw through pre-drilled hole in the front center of DU-HA and screw it into the hole the plastic push pin was removed from. *(The Lag Screw screws into a metal plate with a pre-drilled hole in it.)*
- 6 If desired, install Foam / Plastic Organizers/Gun Rack (B) (C) by sliding them into slots in the DU-HA (as shown). The Foam Organizer with larger slots needs to be installed on passenger side. Gun butts need to sit on passenger side so guns fit properly.



Safety Instructions:

Warning: Seat bottom must be latched down at all times while vehicle is moving. Make sure the DU-HA is secured in the vehicle according to installation instructions. Do not store explosives or hazardous materials in the DU-HA. Do not place loaded guns in the DU-HA.

For further instructions refer to truck owners manual or contact DU-HA, Inc.

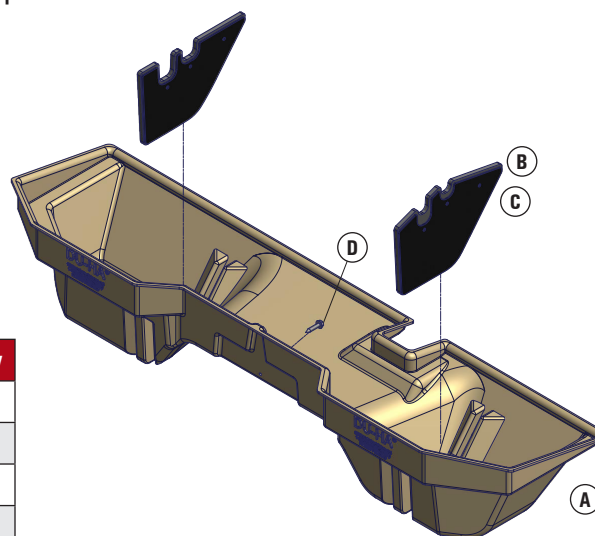

Part	Description	Qty
A	DU-HA Storage Unit	1
B	Foam Organizer / Gun Rack	2
C	Plastic Stiffener	4
D	Lag Screw – 3/8" x 2"	1